



AquaSnap® 80AWH-NG (wall-hung indoor unit)
AquaSnap® 80AWH-NGA (all-in-one indoor unit)
AquaSnap® 30AWH-NG (outdoor unit)

Air-to-Water Heat Pumps

For
Residential
and Light
Commercial
Applications

With R290
Refrigerant



Comfort, Efficiency, and Future-Ready Innovation

Compact, reliable and respectful of the environment, the new AquaSnap AWH-NG(A) represent the top of the range of Carrier branded heat pumps.

With a high water flow temperature of up to 70°C, these monobloc heat pumps are suitable for both new housing and renovation projects, for residential and light commercial applications.

The outdoor unit can be matched with either all-in-one or wall-hung indoor unit, depending on customer's specific installation requirements.

The range uses the natural refrigerant R290 (propane) with a very low GWP100 (Global Warming Potential) of 0.02*. That natural refrigerant is suited for operations even at outside temperatures of -20°C.

This latest series of monobloc air-to-water heat pumps offers a combination of enhanced energy efficiency and quiet performance, providing an even higher level of comfort for heating, cooling, and domestic hot water needs.

AQUASNAP®



ONE RANGE,
MANY APPLICATIONS



Individual
Housing



Collective
Housing



Light
Commercial

* Based on Regulation (EU) 2024/573

Benefits for End Users



Natural Refrigerant

R290 natural refrigerant helps minimize the environmental impact (GWP100 = 0,02*) while offering high energy efficiency.



Increased reliability

AquaSnap AWH-NG(A) prevents insufficient flow rate and provides the defrosting of the outdoor unit, thanks to cycle reversal process.



High Energy Efficiency

SCOP** up to 4,8
SEER up to 7,2
Energy class A+++ (35°C)***
A++ (55°C)***.



Low operating costs

Thanks to high efficiency and self-optimising heat pump.



Elegant and functional design

AquaSnap AWH-NG(A) feature a modern design, that is suitable for any housing setting, whether in newly built houses or in renovations.



Easy control via smartphone

Simple and convenient control of the heat pump from anywhere through Carrier Climate Control.



High LWT (Leaving Water Temperature)

AquaSnap AWH-NG(A) can produce hot water up to 70°C, making it suitable for renovations as it allows the use of existing radiators.



Low-noise operation

With design optimization for low noise levels, the range features quiet operation, with ErP rated sound power levels starting from 51 dB(A).

Benefits for Installers



Easy installation

Optimized layout and structure for easy connection and easy access to components.



Safety

Patented gas separator further prevents refrigerant from entering the heating system in the event of an accident.



Flexibility of choice

A wide range, available from 4 to 16 kW in single phase and three phase versions.



Simplified commissioning

No need to take minimum flow rate and circulation volume or water temperature into account during commissioning.



High integration of hydraulic components

Around 50% fewer components to install. Significantly faster installation (up to 90 minutes time saving) of the indoor unit thanks to the Hydro AutoControl® hydraulic system.



Real time remote monitoring

One single intuitive service app to remotely support technicians in commissioning, diagnostics and troubleshooting the system, throughout its entire service life. Remote monitoring provides essential information in real time.

* Based on Regulation (EU) 2024/573

**Heating performance data to Commission Regulation (EU) No. 813/2013 (average climatic conditions) Low temperature application (W35)

*** The energy efficiency class range of this product category is from G up to A+++

Innovation and Environmental Stewardship

Carrier develops innovative products with the goal to help our customers avoid more than 1 gigaton of greenhouse gas emissions by 2030.

We understand the challenges of climate change and we are committed to providing customers with increasingly more holistic energy and climate solutions.

Our innovative products help customers meet their energy and carbon reduction goals, while we shift to [more renewable energy sources](#) through electrification and to [refrigerants with lower global warming potential](#).

The deployment of Carrier heat pumps to reduce greenhouse gas emissions and energy consumption is just one example.

R290 Natural Refrigerant



Minimizing environmental impact

For the innovative heat pump range AquaSnap AWH-NG(A), Carrier has selected R290 natural refrigerant (propane), featuring an extremely low Global Warming Potential (GWP100 = 0,02)*.

With a zero ozone depletion potential (ODP) and a significantly lower refrigerant charge, compared with traditional refrigerants, R290 natural refrigerant represents an environmentally sustainable choice, reducing equivalent emissions of CO₂ by 99,999 %.

All parts containing greenhouse gas are hermetically sealed, which helps to minimize the potential for leaks and does not require opening to make the system ready for operation.

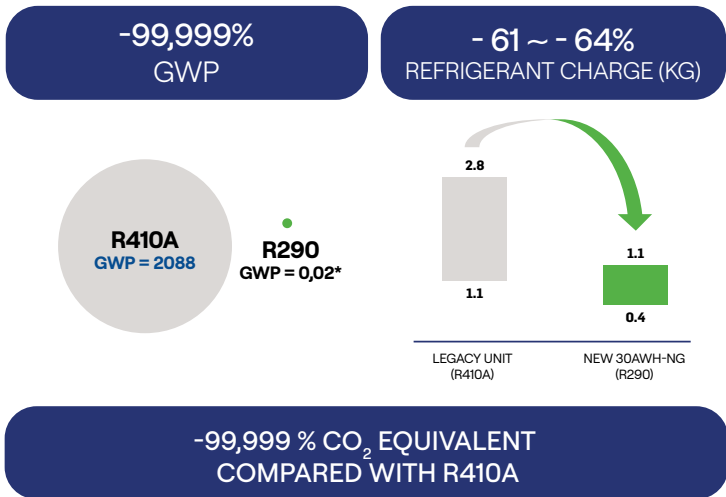

SCOP up to **4,8**

SEER up to **7,2**

Energy savings due to increased energy efficiency

AquaSnap AWH-NG(A) units improve energy efficiency thanks to the high SCOP and SEER. Due to this increased efficiency, the heat pump reduces the amount of energy needed for cooling and heating requirements, providing high comfort and energy saving in all seasons.

Designed and assembled in Europe

Each unit in the AquaSnap AWH-NG(A) range, designed and assembled in Europe at our Carrier plants, is tested over several steps along the production line before packaging, for top level quality.



* Based on Regulation (EU) 2024/573



An Energy-Valuable Solution

All sizes of the AquaSnap AWH-NG(A) range feature the **A+++ energy class for heating** (OAT 7°C; LWT 35°C)* and **A++ (OAT 7°C; LWT 55°C)*** for domestic hot water production, offering high heating power with low energy consumption.

* The energy efficiency class range of this product category is from G up to A+++

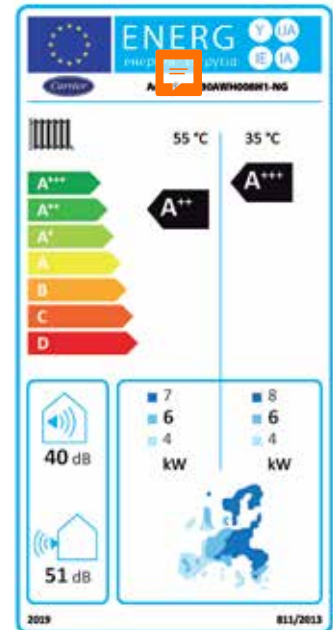

Saving Space and Installation Time

The new-generation AquaSnap AWH-NG(A) heat pumps use a new patented hydraulic system that enables installation and activation in record time.

The patented Hydro AutoControl hydraulic system significantly reduces installation time, as several hydraulic components, as the buffer tank, the expansion vessel and the overflow valve, are already pre-assembled.

Additionally, due to this patent, the overall system's footprint is reduced, and the installation time is up to 90 minutes shorter compared to traditional heat pumps.

With Hydro AutoControl hydraulic system, reliability is provided under all operating conditions, with no need to modify the existing installation.



Efficient Defrosting Through Cycle Reversal

When outside temperatures hover just above freezing, the evaporator of an outdoor air-to-water heat pump can begin to freeze. To prevent this, the evaporator is automatically defrosted using a highly efficient method known as cycle reversal. This process temporarily draws energy from the home's network to heat the evaporator. The Hydro AutoControl hydraulic system provides that there is always enough energy available for effective defrosting.

Year-Round Comfort



The AquaSnap AWH-NG(A) heat pump can be used at a wide range of outdoor air temperatures. As shown in the graphs, in heating mode it can operate from -20°C outdoor air temperature, in cooling mode up to $+45^{\circ}\text{C}$.

Heating mode



Cooling mode

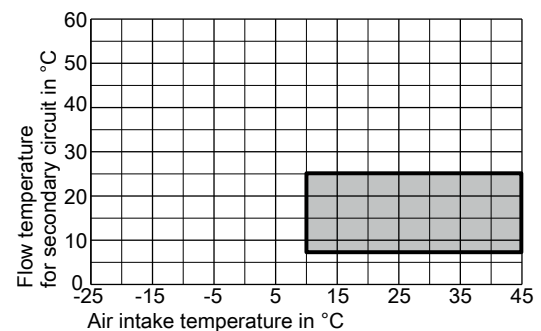

Carrier Climate Control App

With the new Carrier Climate Control App, managing the heating system becomes even easier, thanks to a [new, simple and intuitive user interface](#). A quick glance is enough to check if the system is functioning properly. The Carrier Climate Control App is designed to manage home systems by helping to reduce energy consumption while maintaining high and consistent comfort levels. Temperature and heating schedules, as well as domestic hot water production, are set through daily time slots, which can be programmed independently or with support from the App's heating assistant function. In addition, [technical support is automatically informed of any irregularities](#) and can remotely correct possible causes of a malfunction.



Seamless Energy Monitoring with ViGuide App

Heating contractors can now oversee energy systems online throughout their entire lifespan, either from a desktop PC in the office or from an app on a mobile device, using the ViGuide control tool. [The ViGuide mobile app](#) is used for the [commissioning process](#). This intuitive application guides the installers through each step of the process so that every necessary action is performed completely and in the correct sequence. The [ViGuide web application](#) is, on the other hand, used by the installers to [remotely monitor the heating system](#). Remote monitoring [provides crucial information in real time](#), keeping them up-to-date on every aspect of the system. The event log includes details on system installation, settings, and status messages, [enabling rapid detection and often online troubleshooting of issues](#). This efficient approach saves time, minimizes unnecessary travel, and reduces costs. Customers can feel secure, knowing that their energy system is monitored around the clock and is operating efficiently, giving them peace of mind.

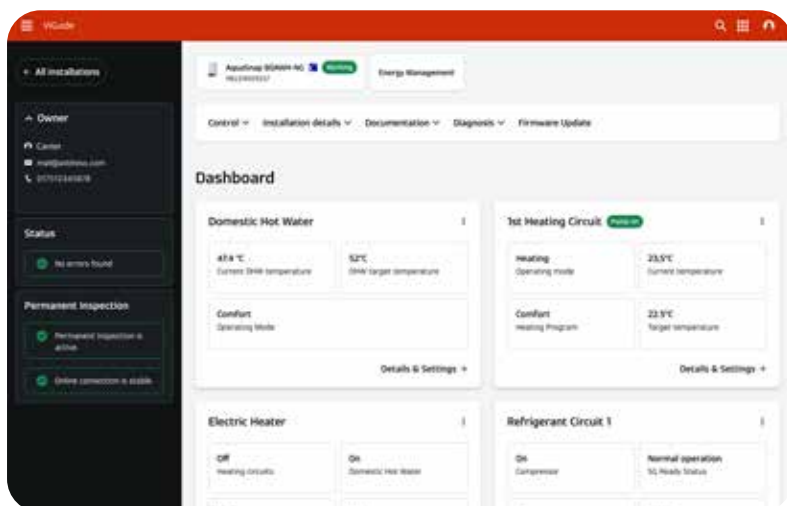



Benefits for installers:

- Commissioning, maintenance, service, and remote monitoring from a single source
- Saving in travel and site visits
- Guided replacement of spare parts for a better service
- Works with any device/application: smartphone/laptop; iOS/Android
- Future-proof system that grows with customer needs

Ideal for Both Renovations and New Builds

With a high leaving water temperature of up to 70°C, AquaSnap AWH-NG(A) are suitable for the replacement of oil and gas boilers and they are ideal for renovations as they allow the use of existing radiators. In addition, they can deliver more hot water and help to avoid the need for direct electric immersion to sterilize the water, protecting from legionella.

Different Terminal Units

terminal units		
Suitable for low, medium and high temperatures.		
		
fan coils	floor heating	radiators

The range has been designed to deliver high performance, suitable for low to medium temperature emitters (floor heating, fan coil units, hydronic cassettes, radiators, mixed installations, etc.) up to high-temperature emitters for renovation applications (boiler replacement).

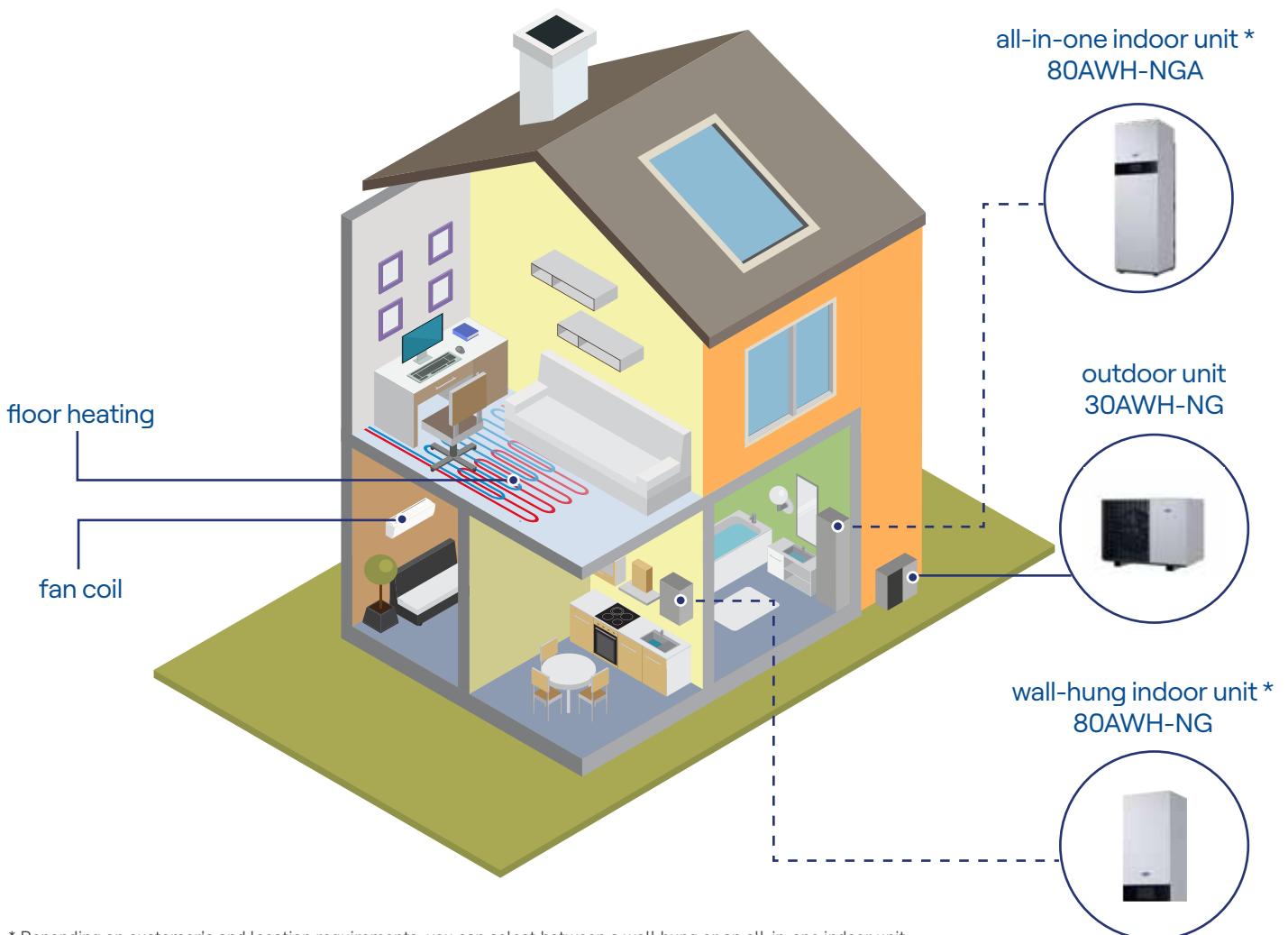

* Depending on customer's and location requirements, you can select between a wall hung or an all-in-one indoor unit. Only one of them is needed to be matched with outdoor unit to offer domestic comfort.
 — — Choose between wall hung or all-in-one floor standing indoor unit.

Dimensions

Outdoor unit 30AWH-NG

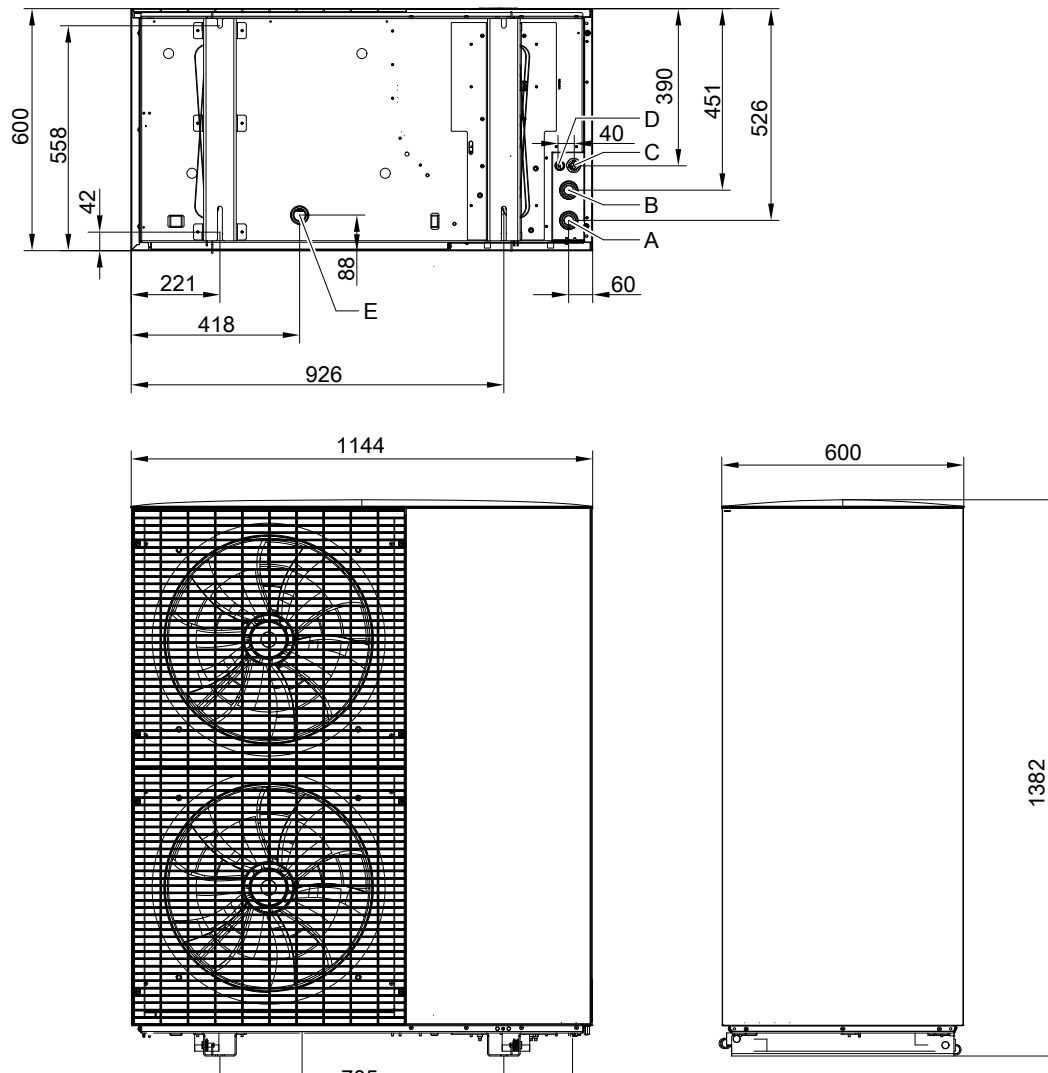

- A** Heating water to indoor unit (heating water outlet): Plug-in connection for Cu 28 × 1.0 mm
- B** Heating water from indoor unit (heating water inlet): Plug-in connection for Cu 28 × 1.0 mm
- C** Power cable
- D** CAN bus communication cable (accessories)
- E** Condensate drain

Dimensions

Wall-hung indoor unit 80AWH-NG

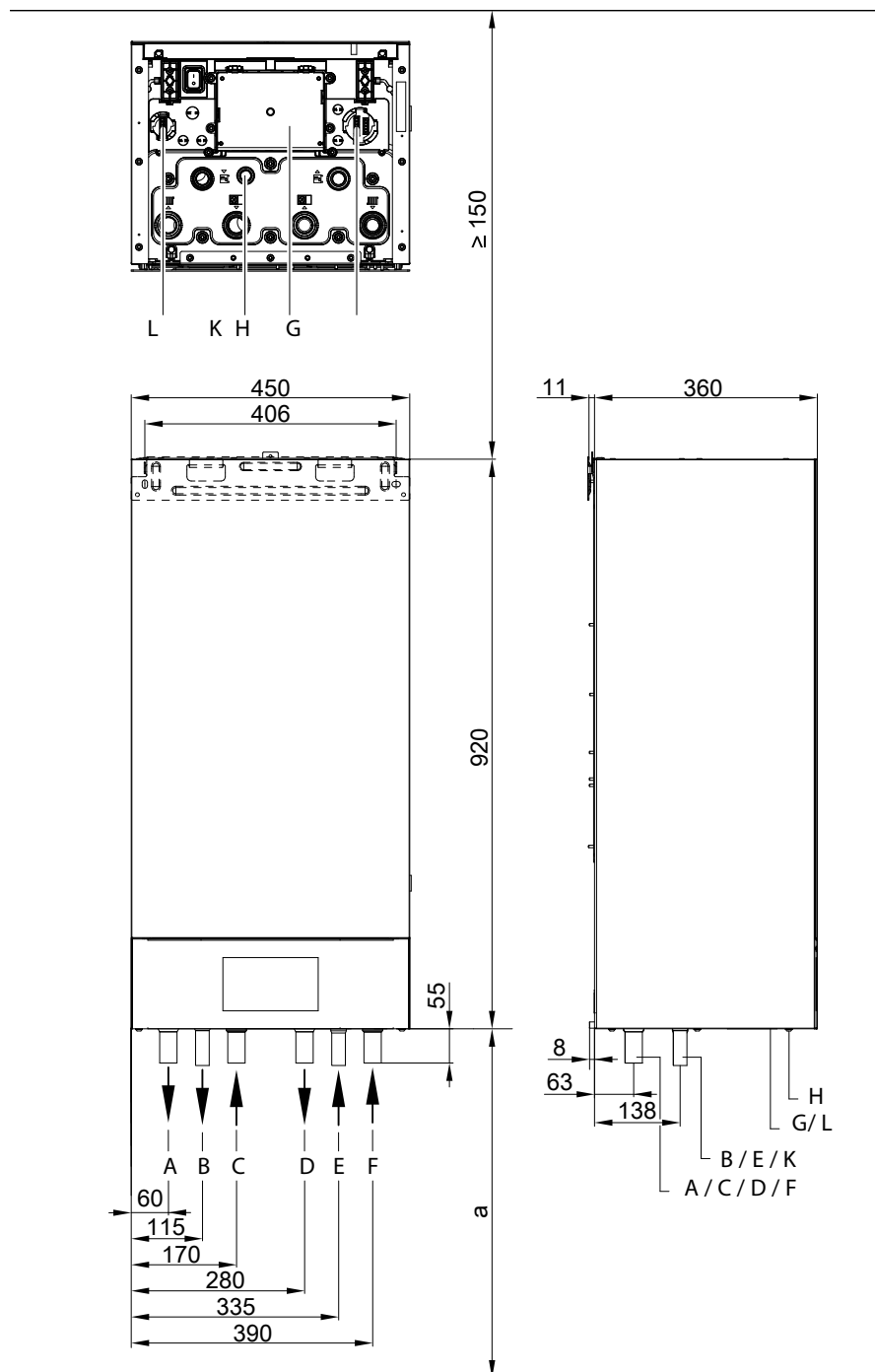

a Min. installation height: Depending on the installation position of programming unit

A Secondary circuit flow (heating/cooling circuit 1/external buffer cylinder), connection Cu 28 × 1.0 mm

B DHW cylinder flow (on the heating water side), connection Cu 22 × 1.0 mm

C Heating water from outdoor unit, connection Cu 28 × 1.0 mm

D Heating water to outdoor unit, connection Cu 28 × 1.0 mm

E DHW cylinder return (on the heating water side), connection Cu 22 × 1.0 mm

F Secondary circuit return (heating/cooling circuit 1/external buffer cylinder), connection Cu 28 × 1.0 mm

G Extra low voltage (ELV) connection sockets < 42 V

H Junction box 230 V~

K Drain hose safety valve

L Extra low voltage (ELV) connection socket < 42 V

Dimensions

All-in-one indoor unit 80AWH-NGA

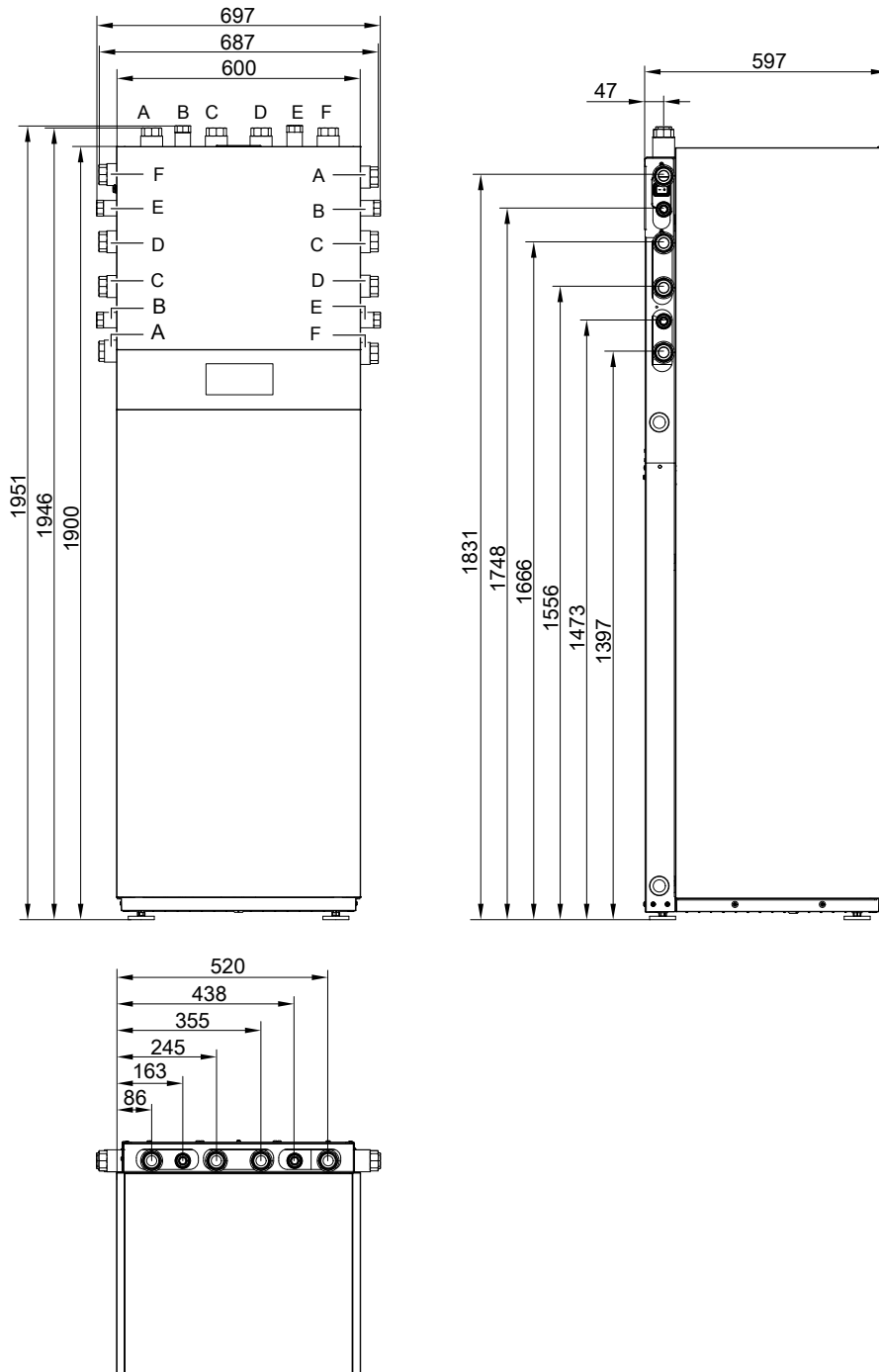

- A** Secondary circuit flow (heating/cooling circuit 1/external buffer cylinder), connection Cu 28 × 1.0 mm
- B** Cold water, connection Cu 22 × 1.0 mm
- C** Heating water from outdoor unit, connection Cu 28 × 1.0 mm

- D** Heating water to outdoor unit, connection Cu 28 × 1.0 mm
- E** DHW, connection Cu 22 × 1.0 mm
- F** Secondary circuit return (heating/cooling circuit 1/external buffer cylinder), connection Cu 28 × 1.0 mm

Dimensions

Outdoor unit 30AWH-NG

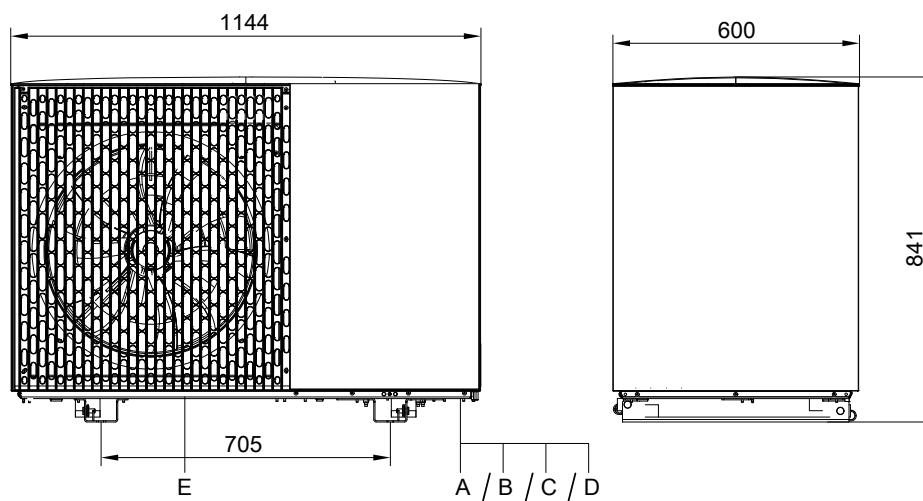
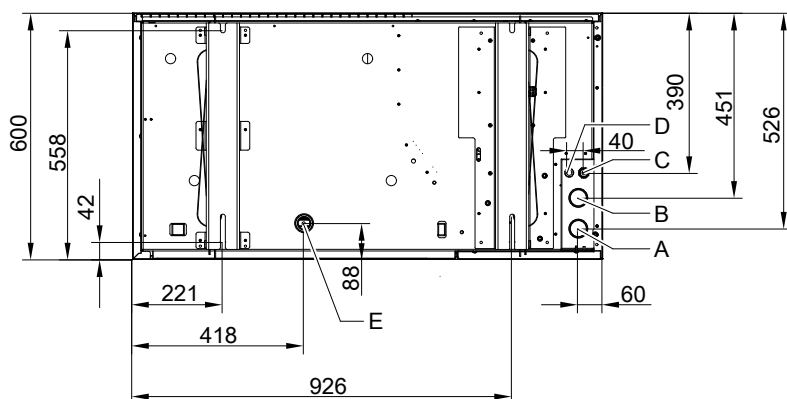

- A** Heating water to indoor unit (heating water outlet): Plug-in connection for Cu 28 × 1.0 mm
- B** Heating water from indoor unit (heating water inlet): Plug-in connection for Cu 28 × 1.0 mm
- C** Power cable
- D** CAN bus communication cable (accessories)
- E** Condensate drain

Indoor Units



80AWH-NG



80AWH-NGA

- 1 Heating water buffer tank (16 litre capacity)
- 2 Diaphragm expansion tank (10 litre capacity) controlled DC fan
- 3 Heating water instantaneous water heater
- 4 Secondary pump (high-efficiency circulation pump)
- 5 Heat pump control with 7-inch color touch display
- 6 Safety valve
- 7 4/3-way valve heating/ DHW heating/bypass

- 1 Heating water buffer tank (16 litre capacity)
- 2 Diaphragm expansion tank (10 litre capacity)
- 3 Heating water instantaneous water heater
- 4 Secondary pump (high-efficiency circulation pump)
- 5 Heat pump control with 7-inch color touch display
- 6 Safety valve
- 7 4/3-way valve heating/ domestic hot water/bypass
- 8 Hot water tank (190 litre capacity)

Outdoor Units

30AWH010, 30AWH013, 30AWH016



- 1 Coated evaporator
- 2 Energy-saving, speed-controlled DC fan
- 3 Inverter-controlled compressor
- 4 Inverter
- 5 Condenser

30AWH004, 30AWH006, 30AWH008



Technical Specifications

AWH-NG/NGA Voltage 230 V		30AWH004	30AWH006	30AWH008	30AWH010		30AWH013		30AWH016		
AWH-NG/NGA Voltage 400 V						30AWH010		30AWH013		30AWH016	
Heating Performance Data*	COP		5,0	4,9	4,7	5,0	5,0	5,0	5,0	4,9	4,9
	Output range	kW	2,1-4,0	2,1-6,0	2,1-8,0	2,6-12,0	2,6-12,0	3,0-13,4	3,0-13,4	3,3-14,9	3,3-14,9
Cooling performance Data**	EER		4,7	4,4	3,9	4,4	4,5	4	4,1	3,7	3,7
	Output range	kW	3,2-4,0	3,2-5,5	3,2-6,7	6,3-14,4	6,5-13,4	6,6-15,7	6,8-14,7	6,9-17	7,1-16
Refrigeration Circuit	Refrigerant		R290	R290	R290	R290	R290	R290	R290	R290	R290
	" Global warming potential (GWP100 acc. to IPCC AR6)"		0,02	0,02	0,02	0,02	0,02	0,02	0,02	0,02	0,02
	Co2 Equivalent	t	0,000024	0,000024	0,000024	0,00004	0,00004	0,00004	0,00004	0,00004	0,00004
	Filling Quantity	kg	1,2	1,2	1,2	2	2	2	2	2	2
Dimensions	Wall-hung IDU (LxWxH)	mm	360 x 450 x 920								
	Floor Standing IDU (LxWxH)	mm	597 x 600 x 1900								
	ODU (LxWxH)	mm	600x1144x84 1				600x1144x1382				
Weight	Wall-hung IDU	kg	47	47	47	47	47	47	47	47	47
	Floor Standing IDU	kg	170	170	170	170	170	170	170	170	170
	ODU	kg	162	162	162	191	197	191	197	191	197
Sound Power		dB(A)	52	52	52	59	59	59	59	59	59
Energy Efficiency ηs at W35		%	176	180	175	190	190	178	178	178	178
Energy Class W35		G -> A+++ (***)	A+++	A+++	A+++	A+++	A+++	A+++	A+++	A+++	A+++
"Energy Efficiency ηs at W55"		%	127	141	137	145	145	141	141	141	141
Energy Class W55		G -> A+++ (***)	A++	A++	A++	A++	A++	A++	A++	A++	A++
Energy Class DHW		%	110	110	110	123	123	123	123	123	123
Energy Class DHW		G -> A+++ (***)	A	A	A	A	A	A+	A+	A+	A+

IDU = Indoor Unit; ODU= Outdoor Unit; DHW= Domestic Hot Water

(*) according to EN 14511 (A7/W35, spread 5 K)

(**) according to EN 14511 (A35/W18, spread 5 K)

(***) The energy efficiency class range of this product category is from G up to A+++

(****) XL Profile - Floor Standing Unit only

More than a century of cool

In 1902, a determined engineer answered one of mankind's most nagging questions: How do we make hot, sticky, indoor air go away? In creating the world's first modern air conditioning system, Willis Carrier forever changed indoor life, and, more than a century later, the corporation that bears his name takes inspiration from his example.

Carrier strives to improve on our founder's breakthroughs, introducing new technologies that make life at home even cooler. Today, a nationwide network of experts continues to advance Willis Carrier's lifework. Your expert Carrier dealer is equipped to evaluate your home and create a customized system designed around your lifestyle.

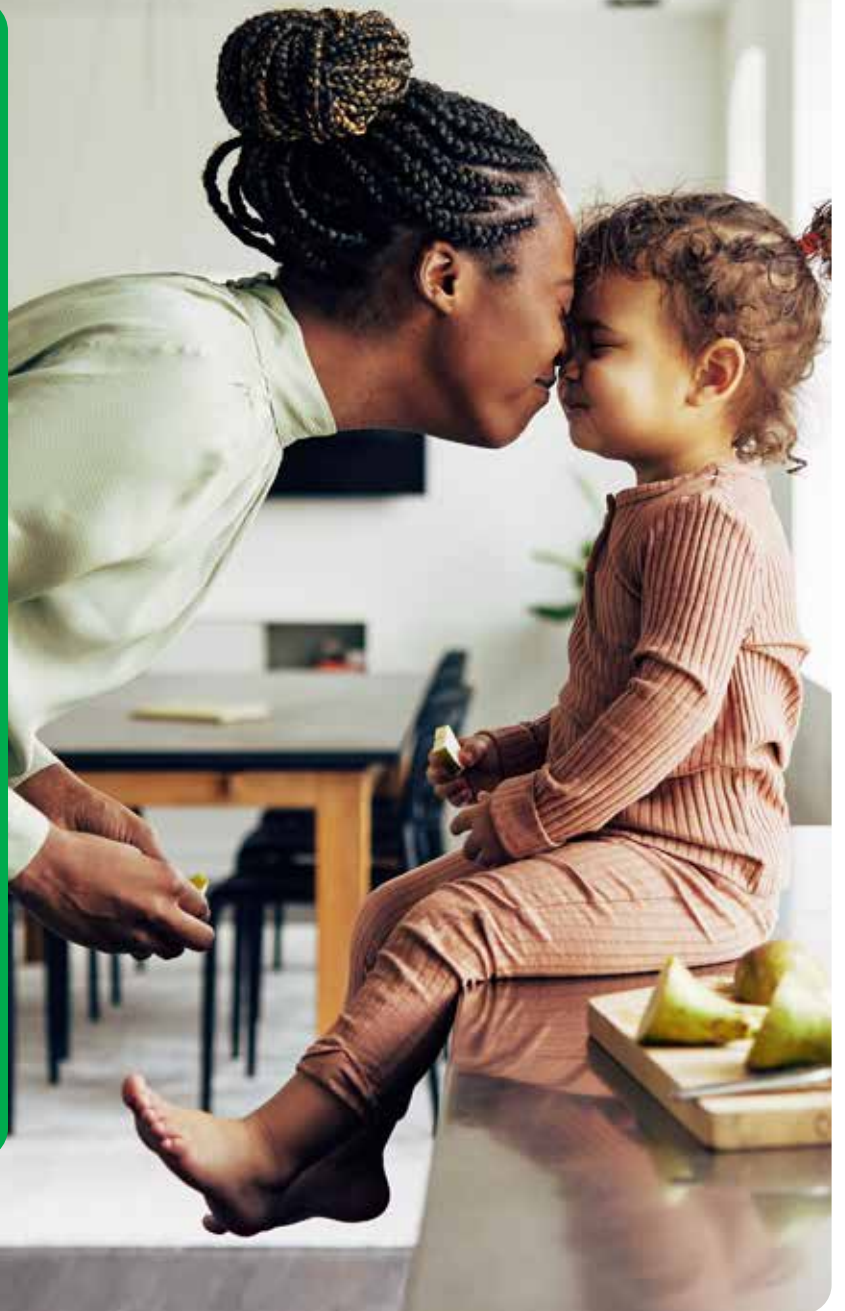

For the  World We Share

carrier.com

B-RLC-040_30AWH-NG / 80AWH-NG/ 80AWH-NGA-EN

©2025 Carrier. All Rights Reserved.

Manufacturer reserves the right to discontinue, or change at any time, specifications or designs without notice or without incurring obligations. Third-party trademarks and logos are the property of their respective owners.